

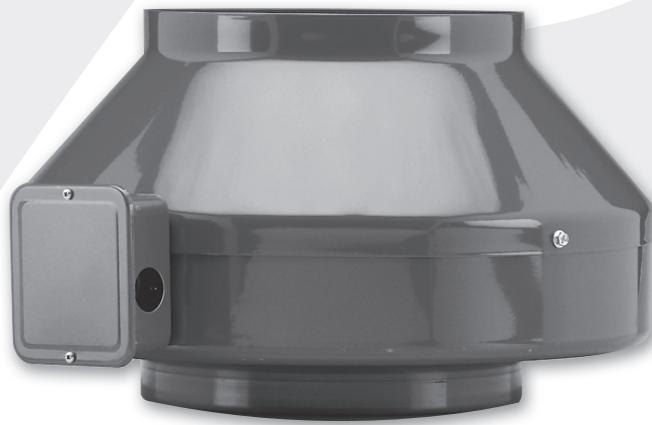

REXJR08



CENTREX REX JR.

Model: REXJR
Direct Drive Centrifugal
Inline Fans

MOVING YOUR WAY

› **Centrex REX Jr. Direct Drive Series**

Model: REXJR

- Static pressure up to 1.5 in. wg.
- Flow capacity up to 711 CFM

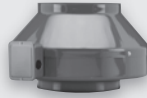

Introduction, Features, Benefits, Options & Accessories.....2
 Dimensional Information & Performance Data3
 Engineering Specifications4
 Limited WarrantyIBC

› **Centrex REX Jr. Centrifugal Inline Fans**

PennBarry certifies that the Centrex REX Jr. Centrifugal Inline Fan models shown herein are licensed to bear the AMCA seal. The ratings shown are based on tests and procedures performed in accordance with AMCA Publication 211 and AMCA Publication 311 and comply with the requirements of the AMCA Certified Ratings Program.



› **UL and CSA Certification**

Centrex REX Jr. Centrifugal Inline Fans carry the UL label, UL 705 (ZACT), listed under File #E28413. Check Underwriters Laboratories Re-Examination Service for specific units listed.



Centrex REX Jr. Centrifugal Inline Exhausters are also certified by the Canadian Standard Association (File #LR13309).



PennBarry reserves the right to make changes at any time, without notice, to models, construction, specifications, options, availability, etc. This bulletin illustrates the appearance of PennBarry products at the time of publication. To view the latest updates, visit PennBarry at www.pennbarry.com.

Introduction

Centrex REX Jr. Centrifugal Inline Fans



Introduction to Centrex REX Jr.

Centrifugal Inline Fans

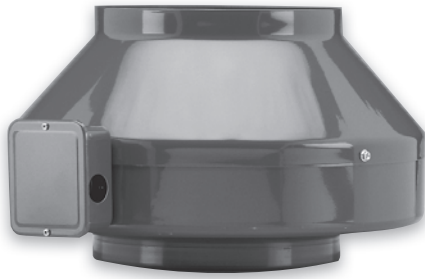

› Centrex REX Jr. Centrifugal Inline Fans

Centrex REX Jr. is a direct drive centrifugal inline fan designed for moderate ventilation requirements.

› Centrex REX Jr. Direct Drive Series

Model: REXJR

- Static pressure up to 1.5 in. wg.
- Flow capacity up to 711 CFM

Features & Benefits

- True airfoil backward inclined wheel.
- Self-lubricating/sealed-for-life precision ball bearings.
- Automatic reset thermal overload protection.
- Capable of operation in air stream temperatures up to 140°F (60°C).
- Galvanized steel housing with electrostatically applied polyester/epoxy urethane powder coat finish.
- Terminal box with prewired electrical strip.
- External rotor motor, class B insulation.

This product is not warranted for corrosive applications. Mounting brackets are included with all Centrex REX Jr. fans.

Options & Accessories

› Lek-Trol™ Controllers

Lek-Trol™ speed controller, model LT 30, is available for all models. It can reduce the airflow rate by 60%.

› Backdraft Dampers

24 gauge galvanized casing with aluminum blades.

› Available Lek-Trol™ Speed Controls

Model	D
REX04J	4"
REX04JX	4"
REX05J	5"
REX05J	5"
REX06J	6"
REX06JX	6"
REX08J	8"
REX08JX	8"
REX10J	10"
REX10JX	10"
REX10JX	12 3/4"

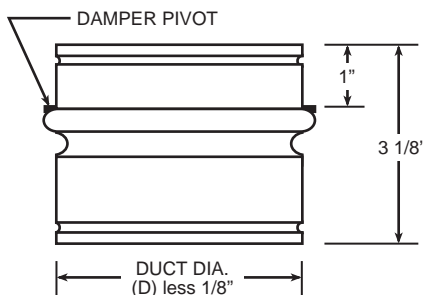

All diameters are 1/8" less whole sizes.

› Fan Curves

The fan curves illustrated below show the range of capacities available for direct drive units. Each graph shows the performance of several models at one particular nominal speed. Fan curves provide a quick method for selecting a fan unit based on design point requirements.

The direct drive performance chart on the following page provides the tabular data (CFM and static pressure) used to plot the fan curves. In addition, the horsepower, tip speed and sones are tabulated. Since sound is normally an important factor in the selection of a fan, an engineer will usually want to select the "slowest" unit which meets CFM and SP requirements.

› Nominal 2500 RPM

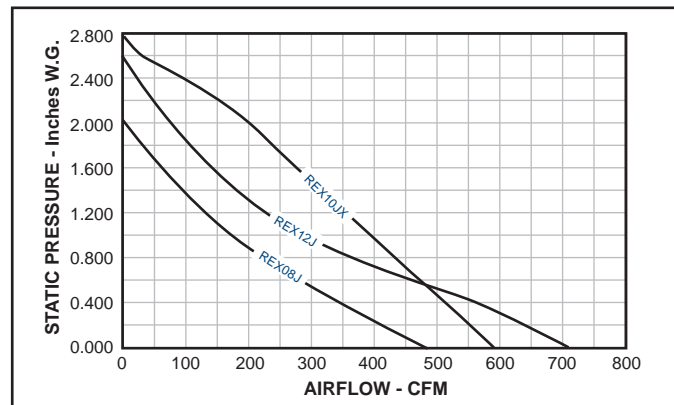

› Nominal 2800 RPM

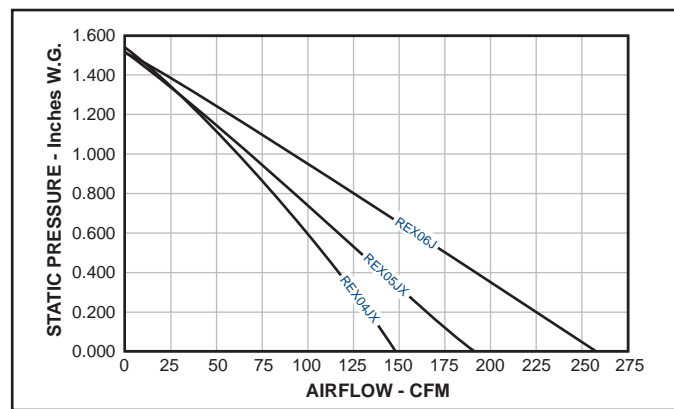

› Nominal 2950 RPM

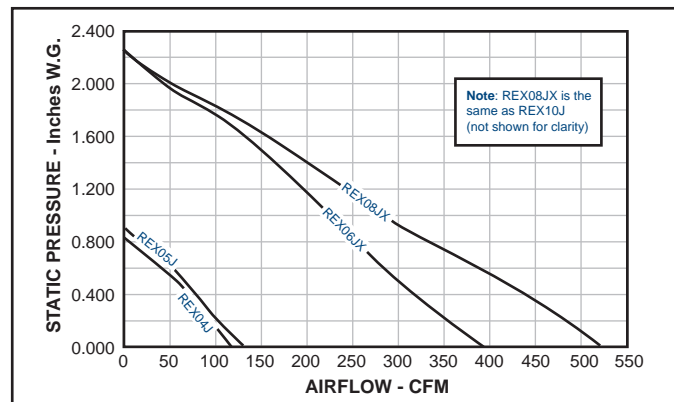

› Centrex REX Jr. Dimensional Data

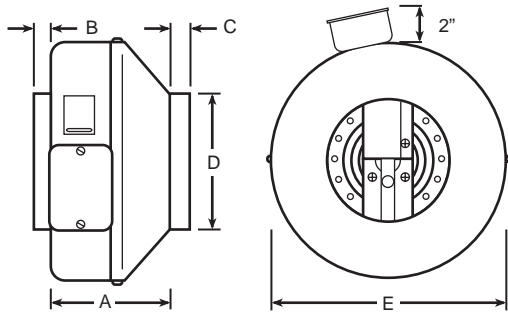

Model No.	A	B	C	D	E
REX04J	6 ½	⅞	⅞	4	8
REX04JX	6	⅞	¾	4	9 ½
REX05J	5 ½	⅞	⅞	5	8
REX05JX	4 ½	⅞	1	5	9 ½
REX06J	6	1 ¼	⅞	6	11 ½
REX06JX	6	1 ¼	⅞	6	13 ¼
REX08J	6 ¼	1 ¼	⅞	8	13 ¼
REX08JX	6 ¼	1 ¼	⅞	8	13 ¼
REX10J	5 ¼	1 ¼	1	10	13 ¼
REX10JX	5 ¼	1 ¼	1	10	13 ¼
REX12J	8 ¼	1 ¼	1 ¼	12 ¾	16

Dimensions are in inches.

› Centrex REX Jr. Performance Data

Model	Max Watts	RPM	Tip Speed FPM	0.000" SP		0.125" SP		0.250" SP		0.375" SP		0.500" SP		0.750" SP		1.000" SP		1.250" SP		1.500" SP		
				CFM	Sones	CFM	Sones	CFM	Sones	CFM	Sones	CFM	Sones	CFM	Sones	CFM	Sones	CFM	Sones	CFM	Sones	CFM
REX04J	44	2950	4016	117	4.5	101	4.2	86	4	72	3.8	58	3.8	-	-	-	-	-	-	-	-	-
REX04JX	83	2800	5424	148	6.5	139	6.7	130	6.9	120	7.3	111	7.7	90	8.1	68	8.3	42	8.4	-	-	-
REX05J	42	2950	4016	132	4.8	115	4.3	98	4.1	81	4	65	3.9	-	-	-	-	-	-	-	-	-
REX05JX	87	2800	5424	191	6.8	175	6.9	161	7	146	7.3	131	7.7	102	8.5	75	8.6	45	8.7	-	-	-
REX06J	84	2680	5192	257	6.7	241	6.5	221	6.5	197	6.4	178	6.3	143	6.2	99	6.6	59	7.1	-	-	-
REX06JX	147	2930	6674	392	10.8	368	10.8	346	10.8	326	10.8	305	10.7	263	10.2	228	10	191	9.7	150	9.8	-
REX08J	119	2580	5876	481	9.1	444	8.4	403	7.7	361	7.3	319	7.1	237	7.3	177	7.6	130	8	76	8.6	-
REX08JX	152	2930	6674	521	11.4	496	10.9	469	10.5	440	10	411	9.7	345	9.3	282	9.8	231	10.2	180	10.6	-
REX10J	147	2930	6674	521	12.3	499	11.8	475	11.3	448	10.9	418	10.6	357	9.8	293	9.4	234	9.2	176	9.3	-
REX10JX	242	2460	6376	590	12.7	565	12.4	541	12.1	519	11.9	496	11.6	442	11.1	394	10.7	339	10.4	290	10.3	-
REX12J	196	2450	6350	711	11.5	675	10.4	627	9.5	576	8.8	521	7.3	382	6.1	284	7.2	220	8	166	8.8	-

› Centrex REX Jr. Sound Power Levels

Model	CFM	Static Pressure	Nominal RPM	Sound Power Levels (dB re 10 ⁻¹² watts) Octave Band Center Frequency (Hz)							
				63	125	250	500	1000	2000	4000	8000
REX04J	148	0	2800	55	62	67	64	62	56	51	43
	42	1.25	2800	58	58	66	62	69	59	55	52
REX04JX	148	0	2800	55	62	67	64	62	56	51	43
	42	1.25	2800	58	58	66	62	69	59	55	52
REX05J	132	0	2950	57	56	61	61	57	54	44	31
	98	0.25	2950	45	56	59	60	55	50	38	27
REX05JX	65	0.5	2950	45	65	58	58	53	48	35	27
	191	0	2800	49	59	66	67	62	58	52	43
REX06J	131	0.5	2800	57	61	71	67	64	59	52	45
	45	1.25	2800	55	57	71	65	69	60	55	52
REX06JX	257	0	2680	55	57	63	66	61	59	52	46
	178	0.5	2680	58	61	60	64	60	58	52	43
REX08J	59	1.25	2680	53	59	65	64	62	60	56	51
	392	0	2930	60	62	68	76	71	63	59	51
REX08JX	191	1.25	2930	58	68	68	74	69	61	56	47
	481	0	2580	58	60	65	69	67	64	61	55
REX10J	237	0.75	2580	53	70	66	68	62	58	50	40
	76	1.5	2580	55	71	71	69	65	61	55	49
REX10JX	521	0	2930	57	64	68	74	72	68	61	59
	345	0.75	2930	56	68	67	72	68	63	55	48
REX12J	180	1.5	2930	57	74	73	74	68	63	56	48
	521	0	2930	63	63	70	73	71	66	64	64
REX10J	357	0.75	2930	69	69	66	71	68	63	59	56
	176	1.5	2930	63	71	70	71	67	62	57	51
REX10JX	590	0	2460	62	68	72	74	72	68	65	62
	442	0.75	2460	64	67	73	73	70	65	62	57
REX12J	290	1.5	2460	67	69	73	72	69	63	58	53
	711	0	2450	60	60	64	71	68	65	63	64
REX12J	382	0.75	2450	56	60	62	62	61	56	51	47
	166	1.5	2450	61	68	68	68	67	61	56	52

The sound ratings shown are in decibels, referred to 10-12 Watts calculated per AMCA Standard 301. Values shown are for inlet (LW) sound power levels for installation Type D; Ducted Inlet, Ducted Outlet. Performance ratings do not include the effects of appurtenances in the airstream

Engineering Specifications

Centrex REX Jr. Centrifugal Inline Fans



Suggested Specifications

Centrifugal Inline Fans

› Model

REX04J
REX04JX
REX05J
REX05JX
REX06J
REX06JX
REX08J
REX08JX
REX10J
REX10JX
REX12J

› Damper

0 = None
BDD = Gravity Backdraft Damper
X = Special

› Thermal Overload Protection

0 = None
P = Thermal Overload Protection

› Speed Controller

0 = None
L = Loose
M = Mounted
X = Special

› Centrex REX Jr.

Centrifugal Inline Exhaust Fans shall be Centrex Rex Jr. Direct Drive, by PennBarry, Richardson, Texas 75081. Fan housing shall be constructed of heavy gauge galvanized sheet metal with a powder coated finish. Internal air turning vanes shall be provided for maximum air performance. Fan shall be supplied with externally mounted electrical terminal box with pre-wired terminal strip connections.

Motorized impeller shall be an external rotor type, class B insulation, totally enclosed with permanent split capacitor (except REX04J and REX05J, shaded pole type). Motor shall be permanently sealed self lubricating ball bearing type. Motor shall be equipped with automatic reset thermal overload protection. Motor shall be acceptable for continuous duty. Sufficient service factor shall be provided to ensure long maintenance free operation over maximum load conditions.

Fan wheel shall be of the backward inclined airfoil type with a well designed inlet venturi for maximum performance. Motorized impeller shall be both statically and dynamically balanced as one integral unit to provide for vibration free performance.

Each fan shall bear the AMCA Licensed Ratings Seal for Air and Sound Performance, and shall be UL and CSA (or equal) listed.

› Product Configuration

Reference PennBarry's selection software to configure a Centrex REX Jr. product today.

C
e
n
t
r
e
x

R
E
X

J
r

©PENNBARRY 2008



Sales Agreement

Centrex REX Jr. Centrifugal Inline Fans

1-Year Limited Warranty

Centrifugal Inline Fans

› Products Covered

PennBarry Fans and Ventilators (each, a “PennBarry Product”)

› One Year Limited Warranty For PennBarry Products

PennBarry warrants to the original commercial purchaser that the PennBarry Products will be free from defects in material and workmanship for a period of one (1) year from the date of shipment.

› Exclusive Remedy

PennBarry will, at its option, repair or replace (without removal or installation) the affected components of any defective PennBarry Product; repair or replace (without removal or installation) the entire defective PennBarry Product; or refund the invoice price of the PennBarry Product. In all cases, a reasonable time period must be allowed for warranty repairs to be completed.

› What You Must Do

In order to make a claim under these warranties:

- You must be the original commercial purchaser of the PennBarry Product.
- You must promptly notify us, within the warranty period, of any defect and provide us with any substantiation that we may reasonably request.
- The PennBarry Product must have been installed and maintained in accordance with good industry practice and any specific PennBarry recommendations.

› Exclusions

These warranties do not cover defects caused by:

- Improper design or operation of the system into which the PennBarry Product is incorporated.
- Improper installation.
- Accident, abuse or misuse.
- Unreasonable use (including any use for non-commercial purposes, failure to provide reasonable and necessary maintenance as specified by PennBarry, misapplication and operation in excess of stated performance characteristics).
- Components not manufactured by PennBarry.

› Limitations

- In all cases, PennBarry reserves the right to fully satisfy its obligations under the Limited Warranties by refunding the invoice price of the defective PennBarry Product (or, if the PennBarry Product has been discontinued, of the most nearly comparable current product).
- PennBarry reserves the right to furnish a substitute or replacement component or product in the event a PennBarry Product or any component of the product is discontinued or otherwise unavailable.
- PennBarry’s only obligation with respect to components not manufactured by PennBarry shall be to pass through the warranty made by the manufacturer of the defective component.

› General

The foregoing warranties are exclusive and in lieu of all other warranties except that of title, whether written, oral or implied, in fact or in law (including any warranty of merchantability or fitness for a particular purpose).

PennBarry hereby disclaims any liability for special, punitive, indirect, incidental or consequential damages, including without limitation lost profits or revenues, loss of use of equipment, cost of capital, cost of substitute products, facilities or services, downtime, shutdown or slowdown costs.

The remedies of the original commercial purchaser set forth herein are exclusive and the liability of PennBarry with respect to the PennBarry Products, whether in contract, tort, warranty, strict liability or other legal theory shall not exceed the invoice price charged by PennBarry to its customer for the affected PennBarry Product at the time the claim is made.

Inquiries regarding these warranties should be sent to: PennBarry, 1401 North Plano Road, Richardson, TX 75081

C
e
n
t
r
e
x

R
E
X

J
r

Other PennBarry Products

Centrifugal Products



› **Domex**
Centrifugal
Roof Exhausters



› **Fumex Fatrap**
Kitchen Hood Centrifugal
Roof Exhausters



› **Zephyr**
Ceiling and Inline Fans

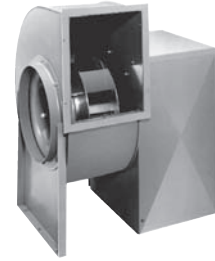

› **Dynamo**
Centrifugal Blowers



› **Centrex Inliner**
Centrifugal Inline Fan



› **LC Dynafan**
Low Contour Centrifugal
Roof Exhausters



› **ESI**
Efficient Silent
Inline Fan



› **Fume Exhaust**
Curb Mounted
Centrifugal Fans

Axial / Gravity Products

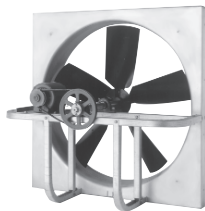

› **Breezeway**
Propeller Wall Fan



› **Hi-Ex**
Power Roof Ventilator



› **Tubeaxial**
Inline Fans



› **Vaneaxial**
Inline Fans



› **Powered Airette**
Axial Roof Ventilators

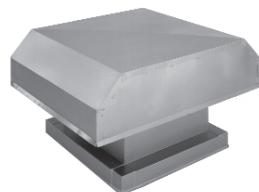

› **Airette**
Gravity Intake/Relief Hood



› **Domex Axial**
Axial Roof Ventilators



› **Axcentrix**
Bifurcator Fan



PENNBARRY™

For more information, contact your local PennBarry Sales
Manufacturer Representative or visit us at www.PennBarry.com.

©2008 PennBarry™ All Rights Reserved. May 2008