

Outdoor Unit: PUHY-P360TSHMU-A – DIMENSIONS

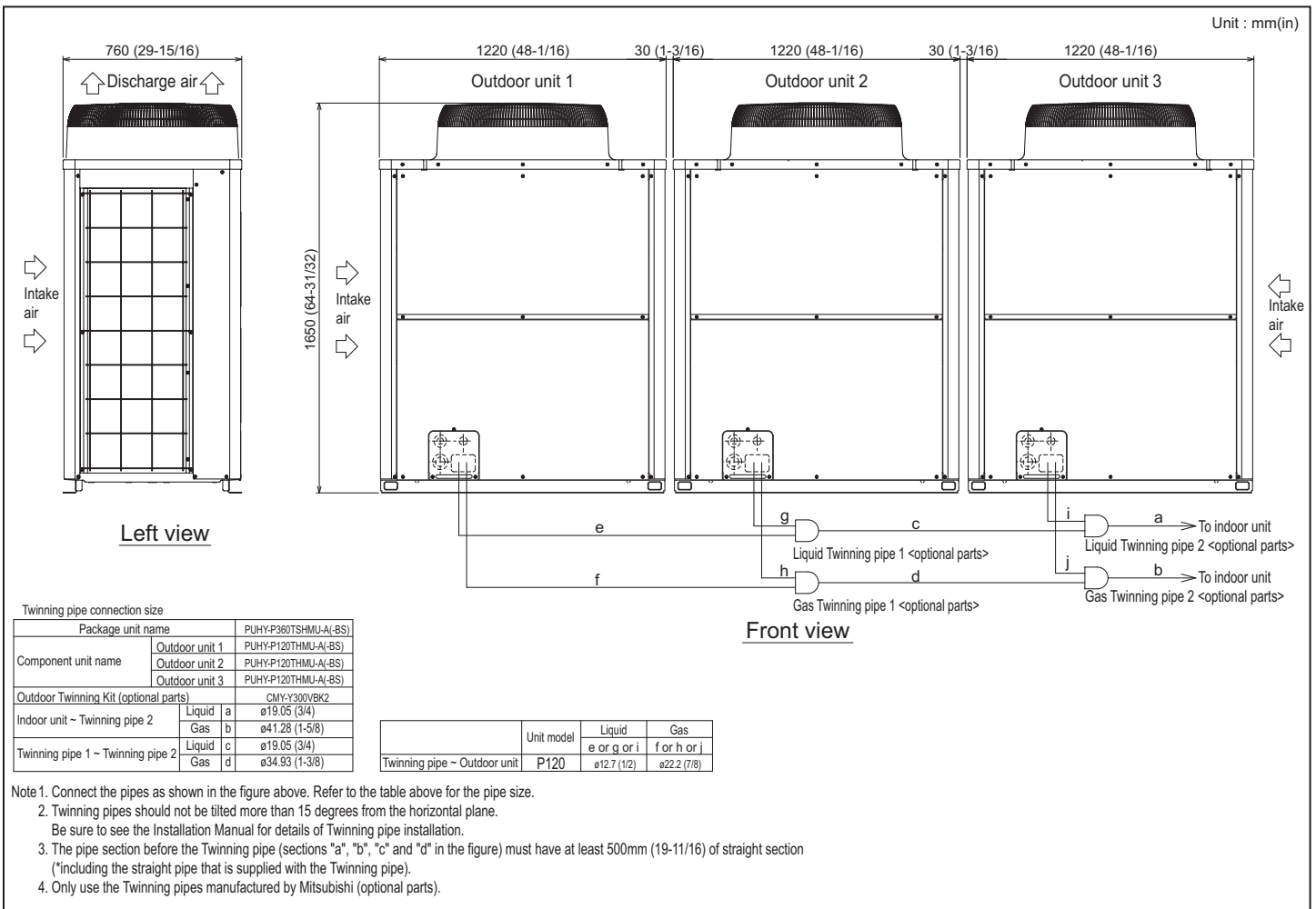

- Note 1. Connect the pipes as shown in the figure above. Refer to the table above for the pipe size.
2. Twinning pipes should not be tilted more than 15 degrees from the horizontal plane.
Be sure to see the Installation Manual for details of Twinning pipe installation.
3. The pipe section before the Twinning pipe (sections "a", "b", "c" and "d" in the figure) must have at least 500mm (19-11/16) of straight section (*including the straight pipe that is supplied with the Twinning pipe).
4. Only use the Twinning pipes manufactured by Mitsubishi (optional parts).

Twinning Kit: CMY-Y300VBK2

CMY-Y300VBK2 Twinning Kit

For Gas pipe:

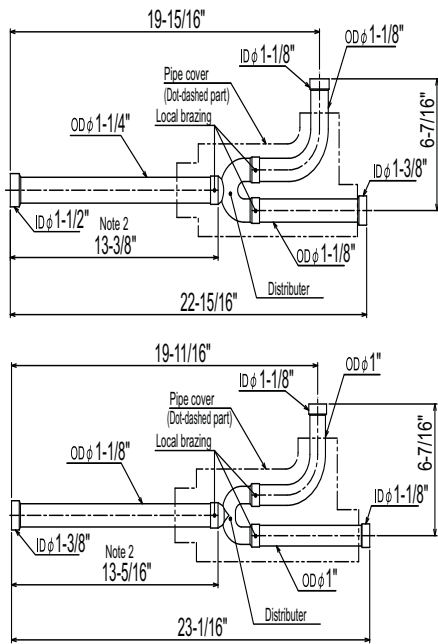

For Liquid pipe:

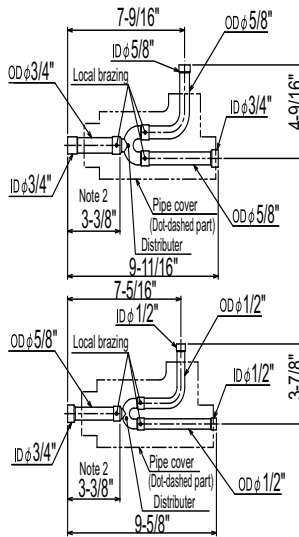

Reducer (Accessory)

Inches

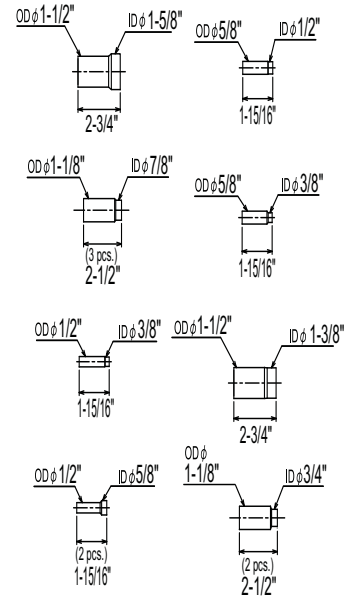

ID: Inner Diameter OD: Outer Diameter

Note 1. Reference the angle of the branch pipe below the fig.

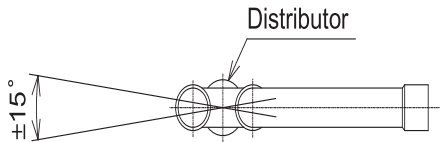

The angle of the branch pipe is within $\pm 15^\circ$ against the ground.

2. Use the attached pipe to braze the port-opening of the distributor.
3. Pipe diameter is indicated by inside diameter.

For instructions on piping the units together using the twinning kit, see the Installation Manual.

Modules 1, 2, and 3: PUHY-P120THMU-A – DIMENSIONS

Unit : mm(in)

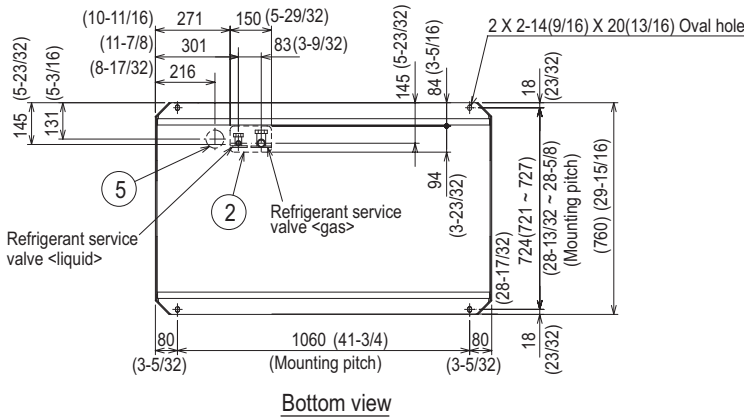
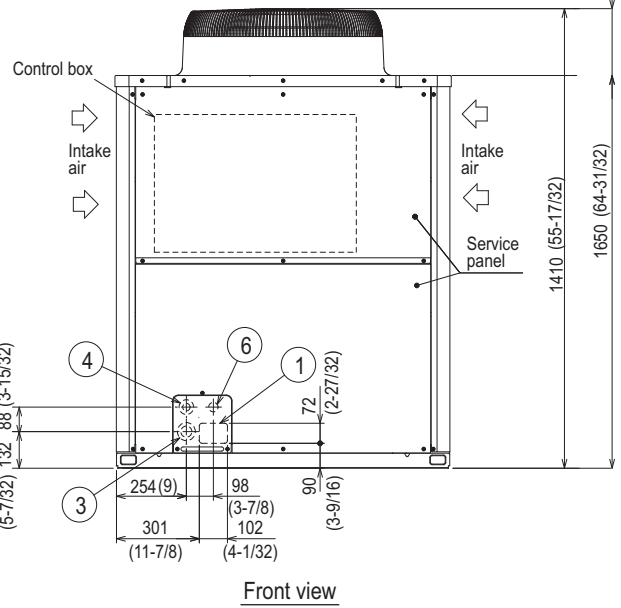
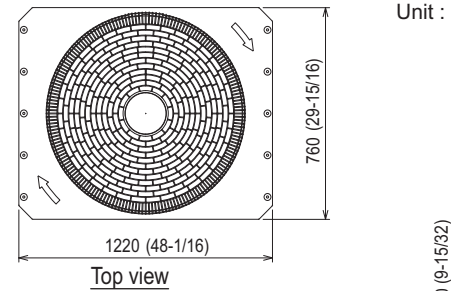
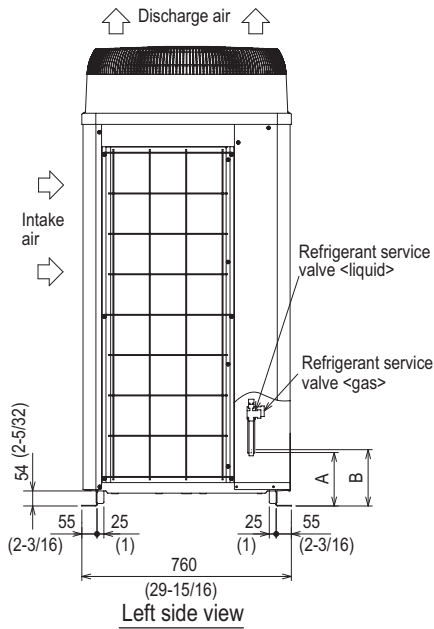

- Accessories**
- Connecting pipe
 - Gas
 - Elbow (IDø25.4 [1] X ODø25.4 [1]) 1 pc.
 - Pipe (IDø25.4 [1] X ODø22.2 [7/8]) 1 pc.
 - Liquid
 - Pipe (IDø15.88 [5/8] X ODø9.52 [3/8]) 1 pc.
 - Pipe (IDø15.88 [5/8] X ODø12.7 [1/2]) 1 pc.

Note 1. Refer to the Engineering or Installation manual for information regarding necessary clearance around the unit, and installation site requirements.
 2. When brazing the pipes, protect the refrigerant service valve by wrapping it with a wet cloth to keep its temperature under 120°C (248°F).

Connecting pipe specifications

| Model | Position dimensions for the refrigerant service valve | | Connection specifications for the refrigerant service valve *1 | |
|--------------------|---|---------------|--|--------------------|
| | Liquid A | Gas B | Liquid | Gas |
| PUHY-P120THMU (BS) | 158 (6-1/4) | 172 (6-25/32) | ø9.52 Brazed (3/8) ø12.7 Brazed (1/2) *2 *3 | ø22.2 Brazed (7/8) |

*1 Use the connecting pipes (for bottom and front pipes) that are supplied.
 *2 Indicates dimensions and connection specifications if the unit is used in combination with other outdoor units.
 *3 Total length ≥ 40m (131')

| NO. | Usage | Specifications |
|-----|--|---|
| ① | For pipes | Front access hole 102 X 72 Knockout hole (4-1/32) (2-27/32) |
| ② | | Bottom access hole 150 X 94 Knockout hole (5-29/32)(3-23/32) |
| ③ | For wires | Front access hole ø62.7 or ø34.5 Knockout hole (2-15/32) (1-3/8) |
| ④ | | Front access hole ø43.7 or ø22.2 Knockout hole (1-3/4) (7/8) |
| ⑤ | Bottom access hole ø65 Knockout hole (2-9/16) | |
| ⑥ | For transmission cables | Front access hole ø34 Knockout hole (1-11/32) |



Mitsubishi Electric Air Conditioning & Refrigeration Systems Works acquired ISO 9001 certification under Series 9000 of the International Standard Organization (ISO) based on a review of quality warranties for the production of refrigeration and air conditioning equipment.

ISO Authorization System
 The ISO 9000 series is a plant authorization system relating to quality warranties as stipulated by the ISO. ISO 9001 certifies quality warranties based on the "design, development, production, installation and auxiliary services" for products built at an authorized plant.



Mitsubishi Electric Air Conditioning & Refrigeration Systems Works acquired environmental management system standard ISO 14001 certification.

The ISO 14000 series is a set of standards applying to environmental protection set by the International Standard Organization (ISO).



HVAC Advanced Products Division
 Mitsubishi Electric & Electronics USA, Inc.

3400 Lawrenceville Suwanee Rd.
 Suwanee, GA 30024
 Tele: 678-376-2900 • Fax: 800-889-9904
 Toll Free: 800-433-4822 (#4)
 www.mehvac.com

Specifications are subject to change without notice.